

MJ2-1741

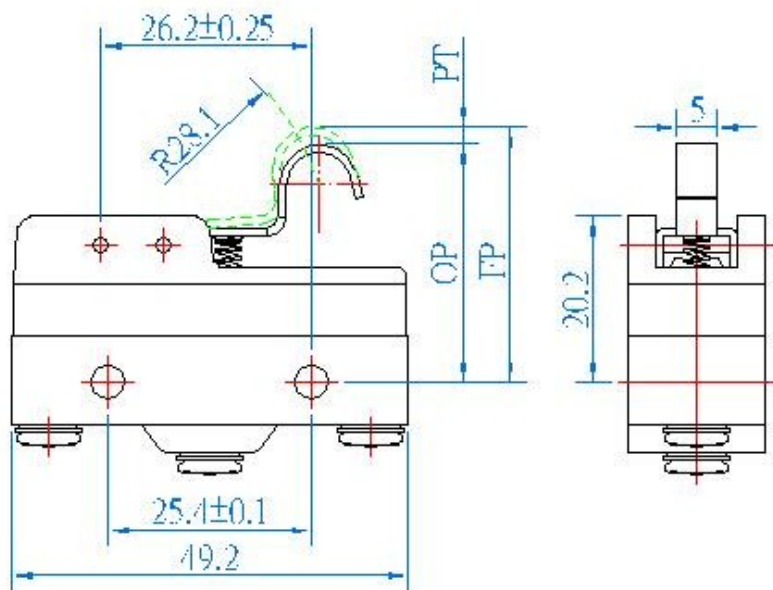

	MJ2-1741
OF MAX	140g
RF MIN	20g
PT MAX	2.1mm
OT MIN	4.7mm
DT MAX	0.5mm
FP MAX	32.1mm
OP	30±0.8mm